



Kit Components

- RayStorm CPU Waterblock
- D5 Vario or X2O 750 Dual Bay Reservoir/Pump
- Copper/Brass Radiator (See Box)
- G1/4" Fittings (Black Chrome) x6
- XSPC 1650rpm 120mm or 1200rpm 140mm Fans
- Fan Grills (Black)
- Intel and AMD RayStorm Brackets
- Socket 1366 and 1155/1154/1150 Backplates
- External Radiator Brackets
- 3mm Twin Blue LED with 4Pin Molex
- 5mm Blue LED with 4Pin Molex
- 2 Meters of Clear 7/16" Hose
- 24pin ATX Bridge Tool
- K2 Thermal Paste



Specification

CPU BLOCK

- G1/4" Threads
- 4x 3mm LED Holes
- AMD Sockets AM2, AM2+, AM3, AM3+, FM1, FM2
- Intel Sockets LGA1366, LGA1156, LGA1155, LGA1150, LGA2011

D5 VARIO PUMP

- 4 Pin Molex with 3pin Tacho Output
- 5 Speed Selector Switch
- Voltage 8-24V (37W Max)
- G1/4" Threads
- 1x 5mm LED hole

X2O 750 PUMP

- 4 Pin Molex
- Voltage 12V (10.5W Max)
- G1/4" Threads
- 1x 5mm LED hole

RADIATOR

- G1/4" Threads
- 6-32 UNC Screws

TUBING

- 7/16" ID, 5/8" OD PVC Tubing (11.1/15.9mm)

120mm FANS

- 1650RPM
- Low Noise (~29dbA)
- Airflow 65.2 CFM
- Static Air Pressure 1.8 mmAq,
- Operating Voltage Range 5.5-13.8V

140mm FANS

- 1350RPM
- Low Noise (~29dbA)
- Airflow 73.92 CFM
- Static Air Pressure 1.23 mmAq
- Operating Voltage Range 5.5-13.8V

Introduction

Thank you for purchasing the XSPC RayStorm WaterCooling kit. RayStorm WaterCooling kits provide excellent cooling performance and low noise levels. The kit is easily expandable, allowing you to add a GPU cooler and additional radiators.

Please read through this installation guide thoroughly before you start installing the kit. It's best to have a clear idea of how you will install the kit before you attempt installation. If you don't understand any part of the installation process please contact us for advice.

After the kit is setup you should leak test for at least 24 hours. While we leak test every component before shipping, you should still leak test it again as a precaution

We hope you enjoy using this kit and it provides you with years of reliable service.

***Disclaimer:** This product is sold as a DIY watercooling kit. You are responsible for correct installation and maintenance of the this product. XSPC will not be held responsible for any loss of property/data or personal harm caused by the improper use or installation of this equipment.*

The components in this kit are supplied with a 12 month manufacturers warranty. This excludes faults caused by incorrect installation or improper use.

Installation Overview

Installation of the kit is split into three main sections. The first is preparation and shows how to prepare the motherboard, pump, radiator, and waterblock, ready for installation. The second is planning the layout and route for the tubing. The last section shows the actual installation process. We highly recommend reading the manual end to end before installation. It will make things easier in the long run

This manual covers several versions of the RayStorm kit, so some steps may not be relevant to your kit. Wether you're using the D5 or X20 750 pump, a 120mm or 140mm radiator, the installation process is basically the same. Installation is relatively straight forward, the key is to thoughtfully plan the layout of the components and tubing.

Preparation – Pages 3-4

Planning – Pages 5-8

Installation - Pages 9-14

Preparing Intel Socket 2011



1. If your motherboard has the 4 threaded holes surrounding the socket use the M4 posts. Otherwise use the backplate method below.

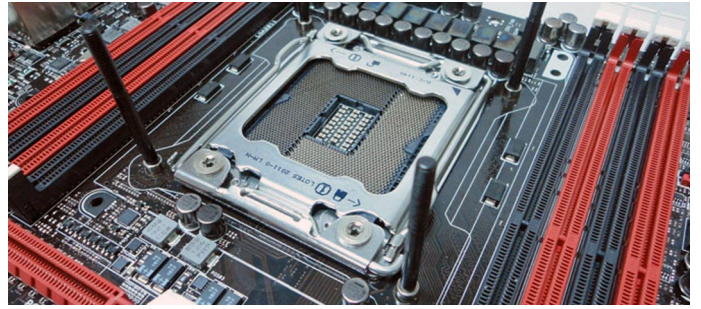

2. Screw the short end of the M4 post into each of the four holes around the socket.

Preparing Intel Sockets 1366, 1155, 1156, 1150

This installation method is suitable for the majority of intel motherboards. This includes some socket 2011 boards without the integrated backplate.

When installing the backplate you should make sure it doesn't make contact with any components or pins on the back of the board. You may have to rotate the backplate to find the correct orientation.

If the backplate still makes contact with pins or other components please contact us for advice.

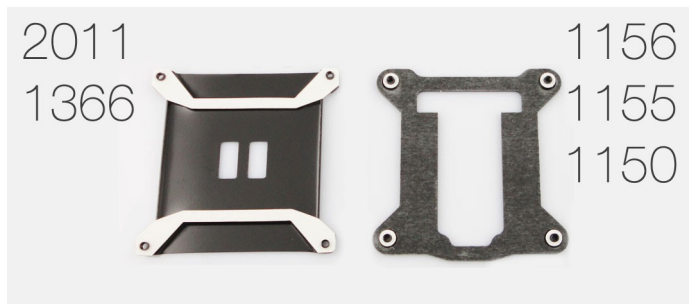

1. Select the correct backplate for your motherboards CPU socket.

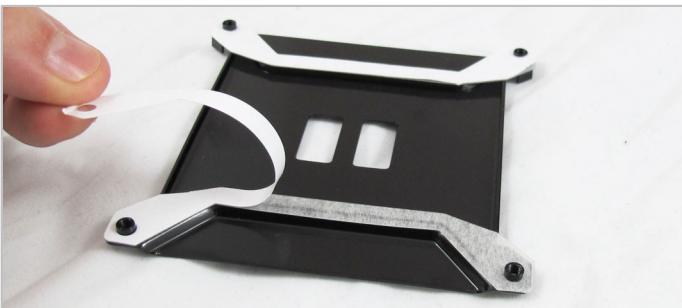

2. Remove the film from the backplate stickers.



3. Place the backplate on the back of the motherboard and line up the holes. Apply pressure to secure.

Preparing AMD Sockets AM2, AM3, FM1, FM2

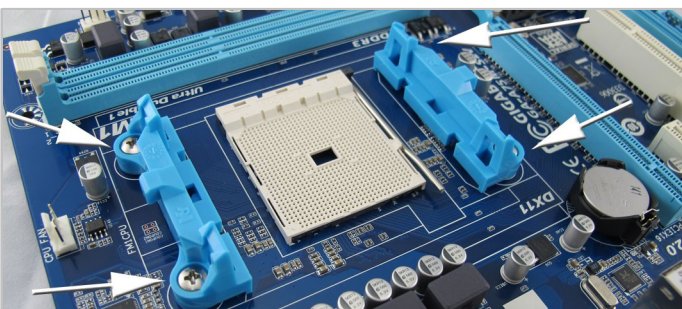

1. Remove the plastic clips on either side of the CPU socket by undoing the 4 screws.

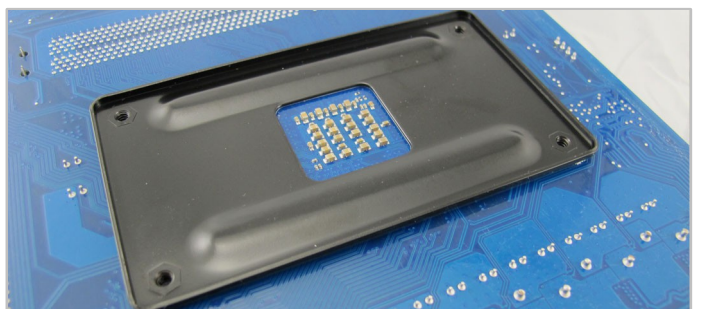

2. If the backplate is loose place it back in its correct position. Make sure the 4 screw threads on the backplate line up with the holes on the motherboard.

Preparing the Radiator



1. Remove the plastic plugs from the G1/4" ports



2. If you're using compression fittings, use a small coin and rotate it clockwise until the o-ring is compressed.



3. If you're using barbed fittings, first hand tighten the barb and finish by using an adjustable spanner. Do not apply too much force as it may cause damage.



4. Using the 30mm 6-32 screws, attach a fan and fan grill to the radiator. Be careful, using screws longer than 30mm will puncture the radiator core.

Preparing the Pump



1. Attach the fittings to the inlet and outlet of the pump. Do not apply too much pressure as this can strip the threads.



2. Push the 5mm LED into the LED holder. You might prefer to do this after installing the kit.

Preparing the WaterBlock



1. Attach the fittings to the inlet and outlet of the pump. Do not apply too much pressure as this can strip the threads.



2. Push the two 3mm LEDs into the LED holders. You might prefer to do this after installing the kit.

Layout and Tubing Routing

Planning the layout of the watercooling loop is the most important part of the installation. It's worth spending some time here to work out the easiest route to connect the block, pump and radiator.

Before you start cutting the tubing to size you should place the components into the best position in your case and when you're happy with the layout, measure and cut the tubing. The following pages show some example layouts and an installation walkthrough of the most common layout.

There are many discussions online about the order of the components and whether the flow should go to the radiator or water block first. Either way will work and while there is a small performance advantage pumping to the radiator first, it's not a significant difference. We would suggest connecting the components in the easiest, shortest route. It's more important to avoid sharp bends in the tubing which could cause kinks and reduce the water flow.

The radiator has no designated inlet and outlet, so you can use either port. The CPU block and pump have assigned inlet and outlet ports which must be followed.

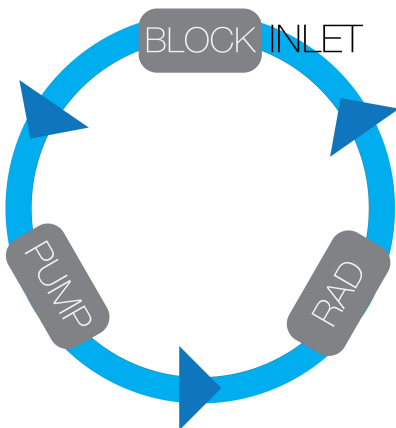

Option 1. Pump > Radiator > Block > Pump

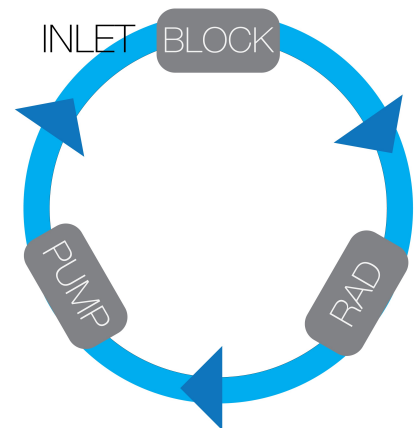

Option 2. Pump > Block > Radiator > Pump

WaterBlock Inlet

It's critical that the water flows into the waterblocks inlet. If the flow direction goes into the outlet then performance will be severely compromised.

This is one of the most common installation mistakes and you should take care to make sure the flow direction goes into the inlet.



Pump Outlet

The inlet and outlet are not marked on the pump, so follow the photos below.

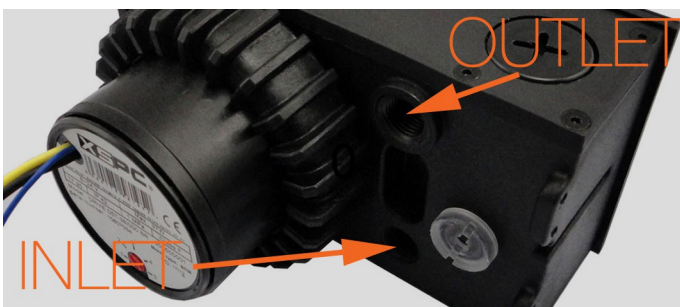

D5 Vario



X20 750

Internal Radiator Layout



Ideally your case will have room to install the radiator internally. This could be at the top, bottom or front of the case. The air should always flow out of the case.

Mounting the radiator internally won't give the best performance, but it's the neatest solution and we highly recommend using it where possible.

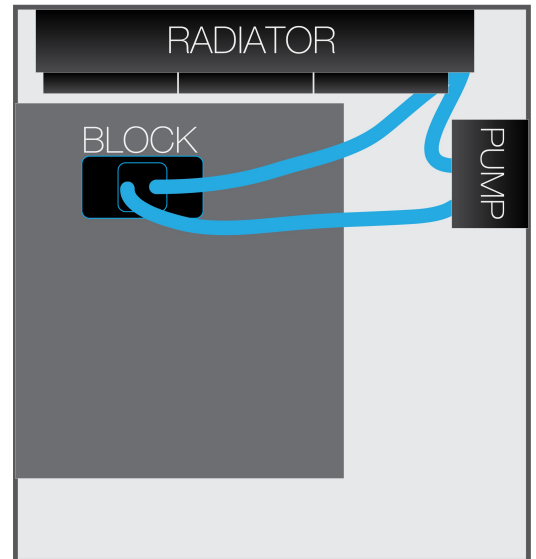

Rear Mounted Radiator Layout



This layout uses the bracket set to attach the radiator to the rear of the case. The brackets can attach to a 120mm or 80mm fan grill. See page 8 for details.

This method will give a better performance because of improved airflow through the radiator.

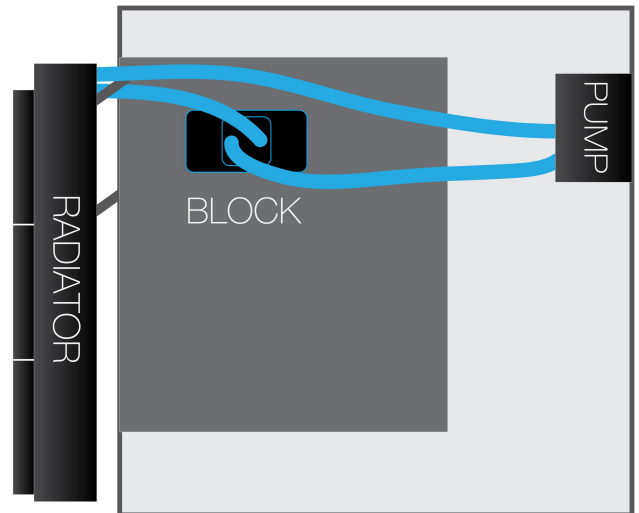

Top Mounted Radiator Layout



This layout uses the bracket set to attach the radiator to the top of the case. You may need to drill 4 holes in your case roof to secure the radiator. See page 8 for details.

Again this method will give a better performance because of improved airflow through the radiator.

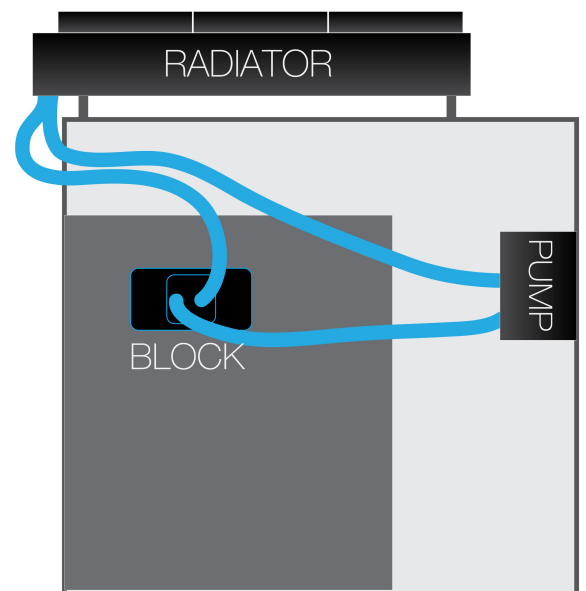

Cutting the Tubing

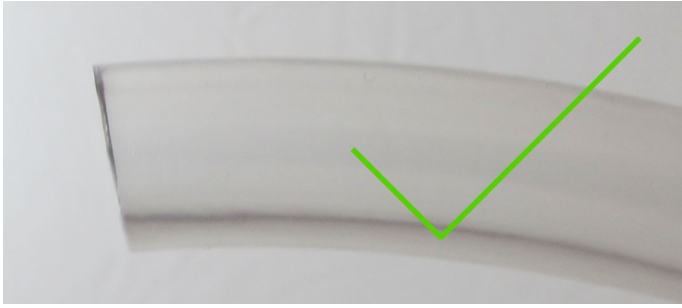

When you cut the tubing it's very important to get a straight clean cut. If you the cut is rough or uneven then it could stop the tubing sealing and cause a leak. You might find it useful to buy a hose cutter instead of using scissors.

Attaching the Tubing (Barbed Fittings)



1. Push the end of the tubing over the barb. The tubing is a tight fit, but this is necessary to avoid leaks.

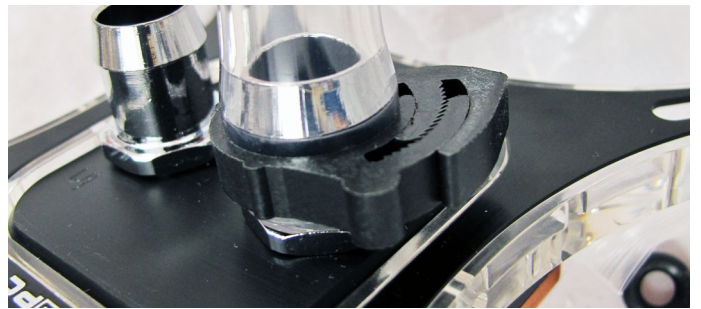

2. Place a hose clip over the lower part of the barb and press the two sides together fix the clip.

Attaching the Tubing (Compression Fittings)

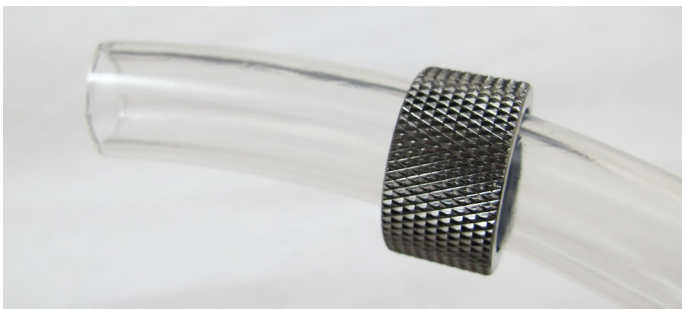

1. Place the cap of the compression fitting over the tubing.



2. Push the end of the tubing over the barb. The tubing is a tight fit, but this is necessary to avoid leaks.



3. Slide the cap over the fitting and rotate it clockwise until the tubing is sealed in place.

Using the Radiator Brackets

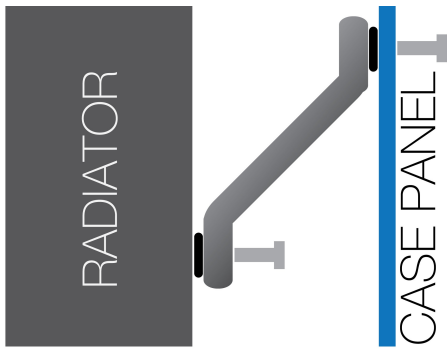

The radiator brackets are useful for mounting the radiator outside of the case. The diagram above shows how to attach the brackets using the provided screws and o-rings.

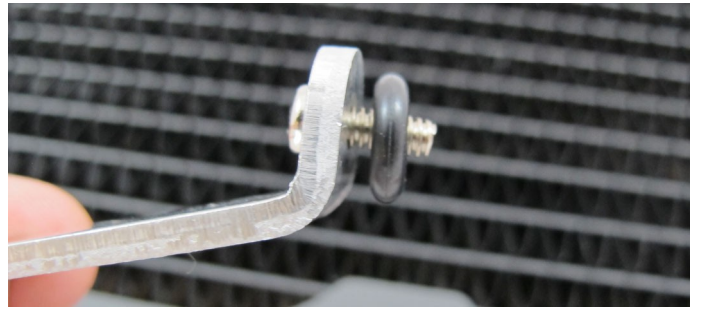

1. Place a screw through the unthreaded hole on the bracket and put an o-ring on the end of the screw.

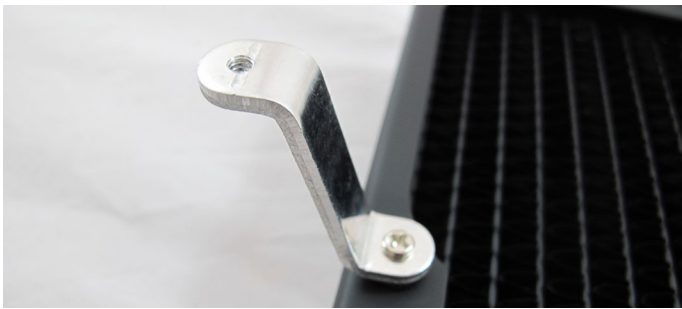

2. Use a screwdriver to attach the bracket to one of the 6-32 threaded holes on the radiator.

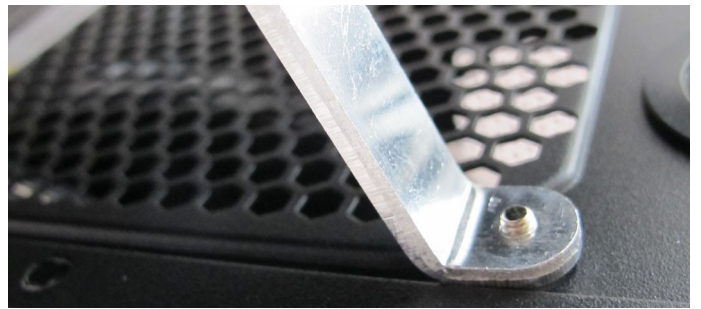

3. Attach the other side of the bracket to the case. An o-ring should be placed between the bracket and case to reduce vibrations.



You can attach to a 120mm fan grill by facing all the brackets in the same direction.

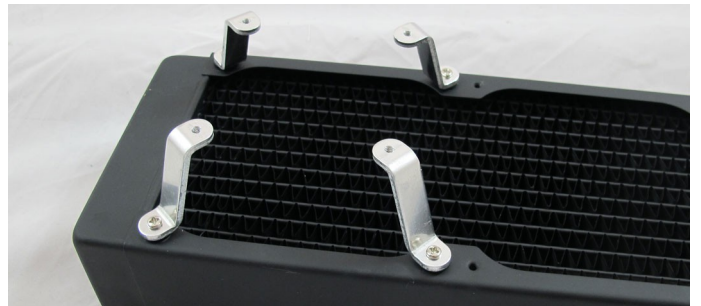

If you rotate the brackets towards the centre they will line up with a 80mm fan grill.



If you are attaching the radiator to the top of the case it's best to spread the brackets out further for more stability.

Attaching the Radiator



1. Lift the radiator into position and line it up with the screw holes on the case panel.



2. Use four 6mm 6-32 screws in each of the four corner holes. Do not use screws longer than 6mm.

Example Installation Walkthrough

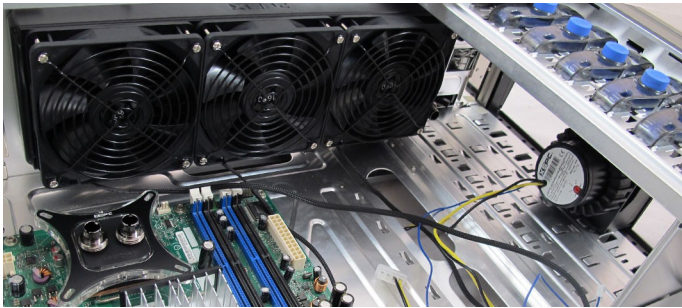

1. Place the motherboard into the case and position the radiator, pump and waterblock into their chosen locations. You might want to try moving the components around to find the best positions for routing tubing.



2. Decide on the loop order and measure the length of tubing for each connection. We advise leaving 5-10cm of slack tubing for the connection to the pump. This will allow you to pull the pump forward for filling and topping up the coolant.

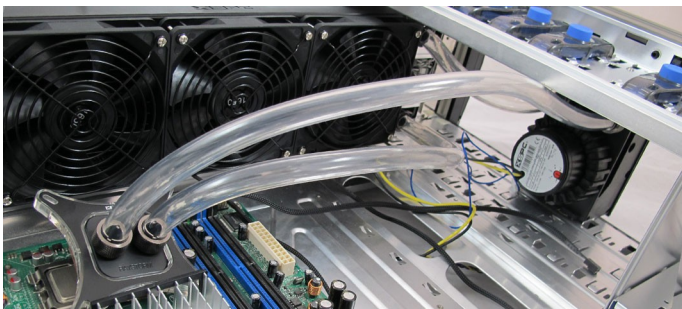

3. Connect the tubing and check all the fittings are sealed. In the photos above the loop order is pump > radiator > CPU block > pump. When the tubing is connected you should make sure it doesn't have any kinks. Kinks will reduce the flow rate and have a significant effect on performance.

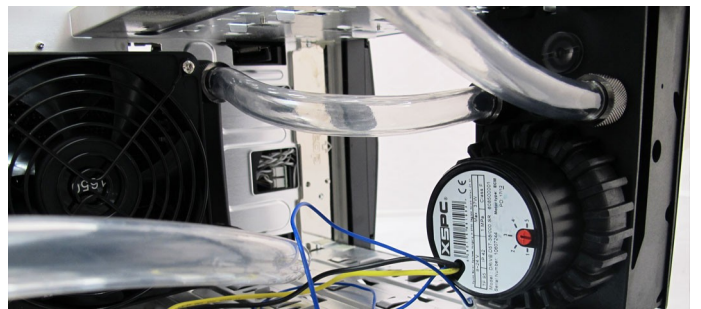

4. You can now remove the motherboard from the system ready for filling and leak testing.

Filling the System



1. Pull the pump forward so you can access the fill cap.



2. Use a small coin to undo the pumps fill cap.

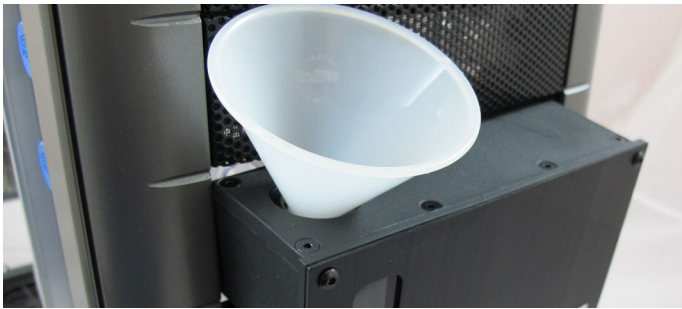

3. Use a small funnel to avoid spilling the coolant.

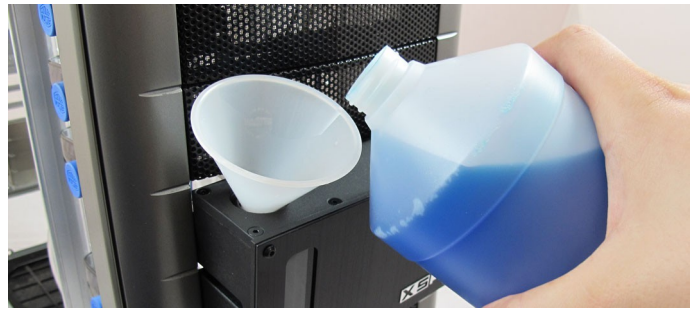

4. We recommend using a premixed coolant like XSPC EC6. This will protect the components and stop biological growth in the loop.



5. Top up the coolant to the top of the viewing window on the front of the pump/reservoir.

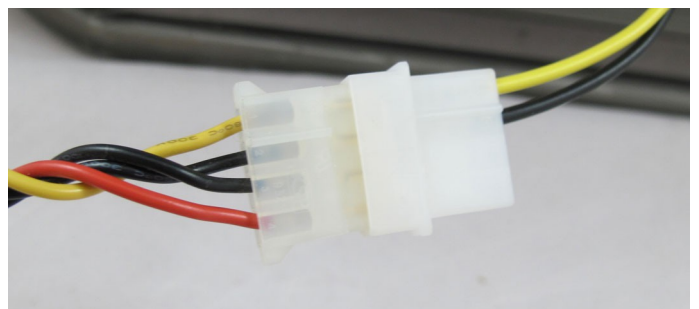

6. Place your PSU outside of the case and attach it to the pumps 4pin molex connector.

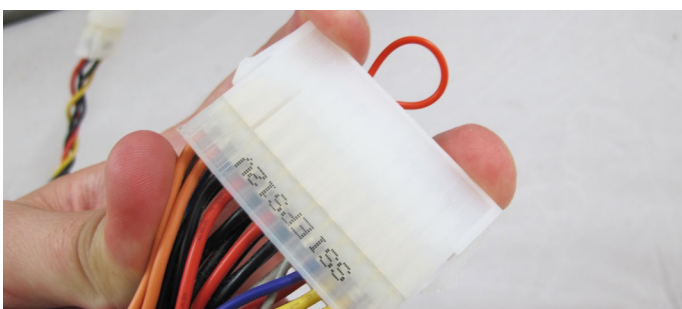

7. Attach the PSU starter block to the 24pin connector. This will allow the PSU to start without the motherboard.

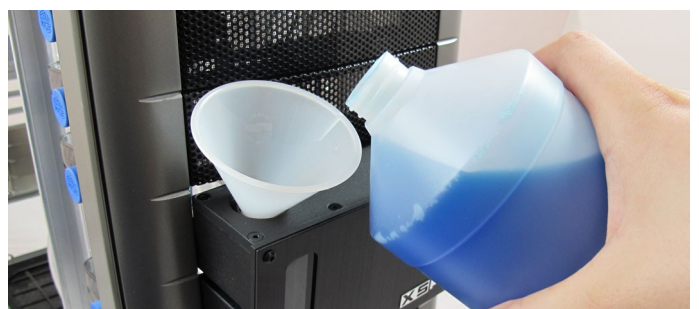

8. When the pump starts the coolant level in the reservoir will drop. You should keep topping up the coolant level while the rest of the system fills up.

9. When the coolant level is stable you should leave the pump running for 24 hours to check for leaks. This will also allow any remaining air to bleed from the loop.

After the leak test you can re-install the motherboard and other PC components into the case.

24 Hours

Attaching the Pump



1. Push the pump back so the faceplate is flush with the front of the case. Fix the pump in place by using the small M3 screws.



2. If you have a case with quick release clips, we recommend removing them and using the screw hole underneath.

Fitting the Waterblock (Intel 1366, 1156, 1150)

The installation process below is shown without the tubing connected. This has been done so the installation process can be seen clearly, without any obstructions.

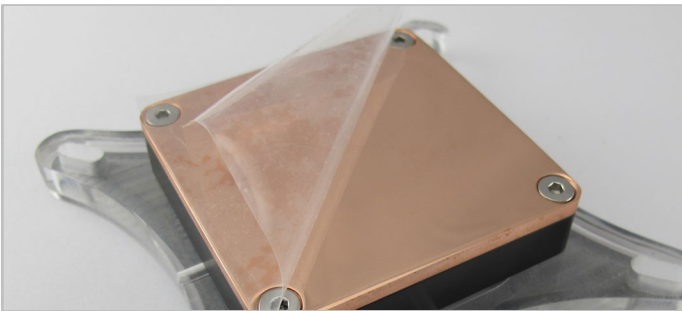

1. Remove the plastic film from the base of the waterblock.



2. Apply a thin layer of thermal paste to the CPU's heat spreader.



3. Place the waterblock onto the CPU and line-up the mounting plate with the holes on the motherboard.



4. Place a spring and washers over each bolt. Bolt > Nut > Spring > Metal washer > Plastic Washer



5. Place each of the bolts through the mounting plate and loosely screw into the backplate using the knurled section of the bolt [A]. When all 4 bolts are loosely fitted, tighten each bolt [A].

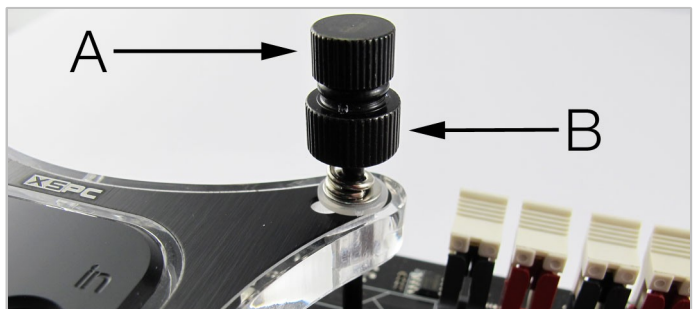

6. Use the lower knurled nut [B] to adjust the pressure on the CPU. Make sure to apply equal pressure to each spring.

Fitting the WaterBlock (Intel 2011)

The installation process below is shown without the tubing connected. This has been done so the installation process can be seen clearly, without any obstructions.

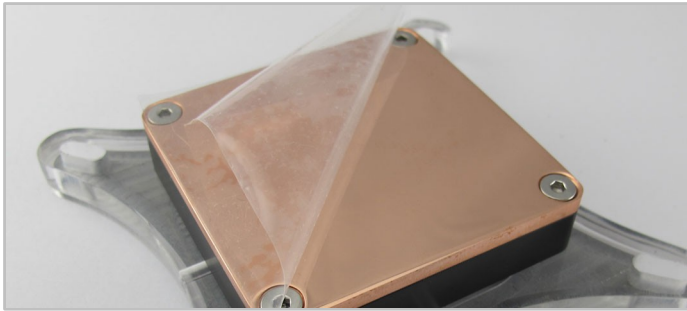

1. Remove the plastic film from the base of the waterblock.



2. Apply a thin layer of thermal paste to the CPU's heat spreader.



3. Place the waterblock over the M4 posts and onto the CPU.



4. Place a plastic washer and metal washer over each of the four posts.



5. Place a spring over each of the four posts.



6. Remove the nut from each of the four bolts in the intel screw set.



7. Place a nut over each post and gradually tighten them. Make sure to apply equal pressure to each spring.

Fitting the Waterblock (AMD)

The installation process below is shown without the tubing connected. This has been done so the installation process can be seen clearly, without any obstructions.

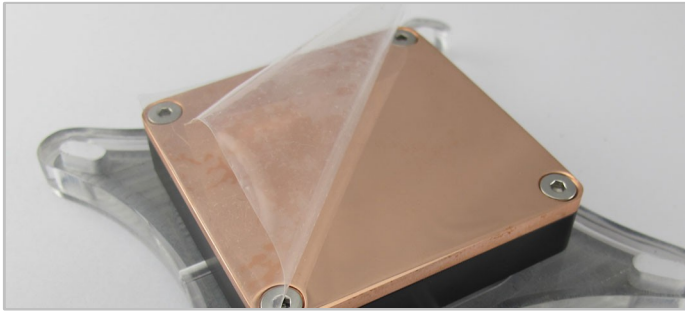

1. Remove the plastic film from the base of the waterblock.



2. Apply a thin layer of thermal paste to the CPU's heat spreader.



3. Place the waterblock onto the CPU and line-up the mounting plate with the holes on the motherboard.



4. Place a spring and washers over each bolt.
Bolt >Nut >Spring >Metal washer >Plastic Washer



5. Place each of the bolts through the mounting plate and loosely screw into the backplate using the knurled section of the bolt [A]. When all 4 bolts are loosely fitted, tighten each bolt [A].

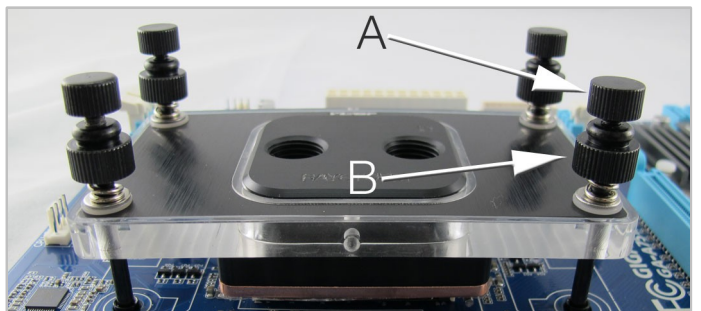

6. Use the lower knurled nut [B] to adjust the pressure on the CPU. Make sure to apply equal pressure to each spring.

Finishing Touches

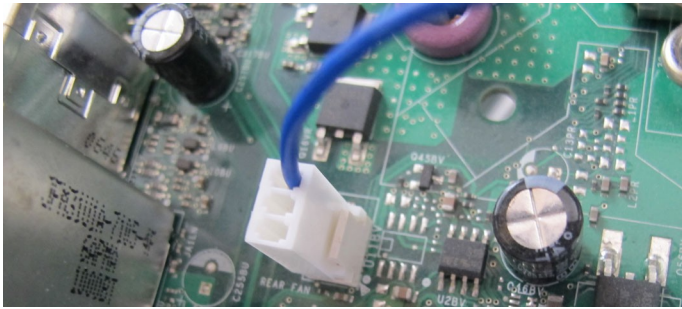

1. Connect the tachometer output from the pump to the motherboard fan header. This will allow you to monitor the pumps speed. (D5 Pump only)

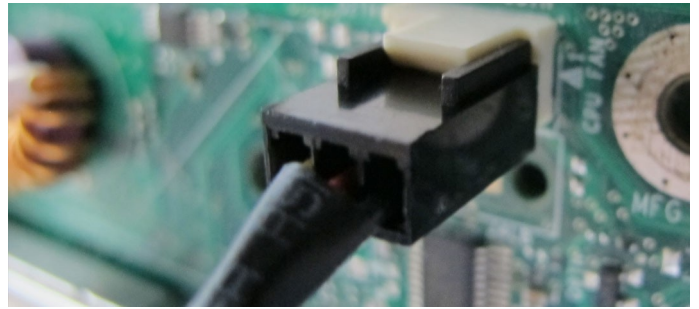

2. Connect the fans to the motherboard fan headers, or a fan controller.



3. Push the two 3mm LEDs into the LED holders and connect the LEDs to the PSU.



4. Push the 5mm LED into the LED holder and connect the LED to the PSU.



5. The dial on the back of the pump can be used to set the pump speed. 5 being full power and 1 being the lowest noise level. (D5 Pump only)

6. Your system is now ready to use. When first booting the system we would suggest monitoring the CPU temperature.

Maintenance

If installed correctly, the watercooling kit requires very little maintenance. In the first week of use we highly recommend checking for leaks on a regular basis and monitoring the coolant level. Long term we recommend the following:

- Clean dust from the radiator every 12 months
- Change the coolant every 12-18 months
- Check the tubing for kinks

If you experience increased temperatures or increased noise you should check the coolant level and check for kinks in the tubing.

Q. I see small bubbles in the water. How do I remove them?

A. These bubbles will normally disappear within 24 hours of use. If they don't you should switch the system off and allow them to settle before restarting.

Q. The water level keep dropping. Do I have a leak?

A. You should check for leaks, but it's normal for the water level to drop after installation. Some air can get trapped inside the radiator and the water level will drop as this is removed.

Q. My CPU temperature seems higher than expected, what could be wrong?

A. 1. Check that the pump is running and water is flowing around the system.
2. Check the tubing for kinks.
3. Check you have removed the plastic film from the base of the CPU block.
4. Check the water flow direction is going into the waterblocks inlet port.
5. The CPU block may be mounted incorrectly. Remove it and try again, making sure to apply equal pressure to each spring.

Q. The pump is making a rattling or vibrating noise.

A. Some noise is normal when you first fill the system. This noise normally disappears after all the air has been removed from the loop. If the noise doesn't go away after 24 hours then try the following.

1. Check the water level.
2. Check the tubing for kinks or any restrictions.
3. If you are using the D5 Vario pump you can reduce the pump speed to reduce vibrations.
4. Sometimes air can get trapped inside the pump. Shaking the pump can help to remove the air.

Q. The pump seems to be running, but the rate flow is very slow.

A. 1. Check the tubing for kinks.
2. As a last resort you can disassemble the waterblock and check for blockages. We have found some customers accidentally drop tissue paper into the reservoir when cleaning up spilt coolant. This flows to the CPU block and causes a blockage.

Q. Can I use tap water?

A. Do not use tap water as it contains many impurities. You should use a premixed coolant like XSPC EC6, which will provide protection against corrosion and biological growth.

Q. I have heard you can use a silver coil and de-ionized water instead of premixed coolant.

A. A silver coil will provide protection against biological growth, but it provides no protection against corrosion. Using a coolant with an anticorrosive will help protect the components and improve long term reliability.

Q. Water is leaking from the connectors, is the product faulty.

A. It's more likely to be caused by incorrect installation. Try tightening the fitting and reconnecting the tubing.

Q. Water is leaking from the radiator core.

A. This is likely to be caused by using the wrong length screws and puncturing the core. This is not covered under warranty, but it could be repaired at a car radiator repair shop.

Q. Water is leaking from the waterblock, radiator, or pump.

A. Please contact XSPC support for advice. www.xs-pc.com/support

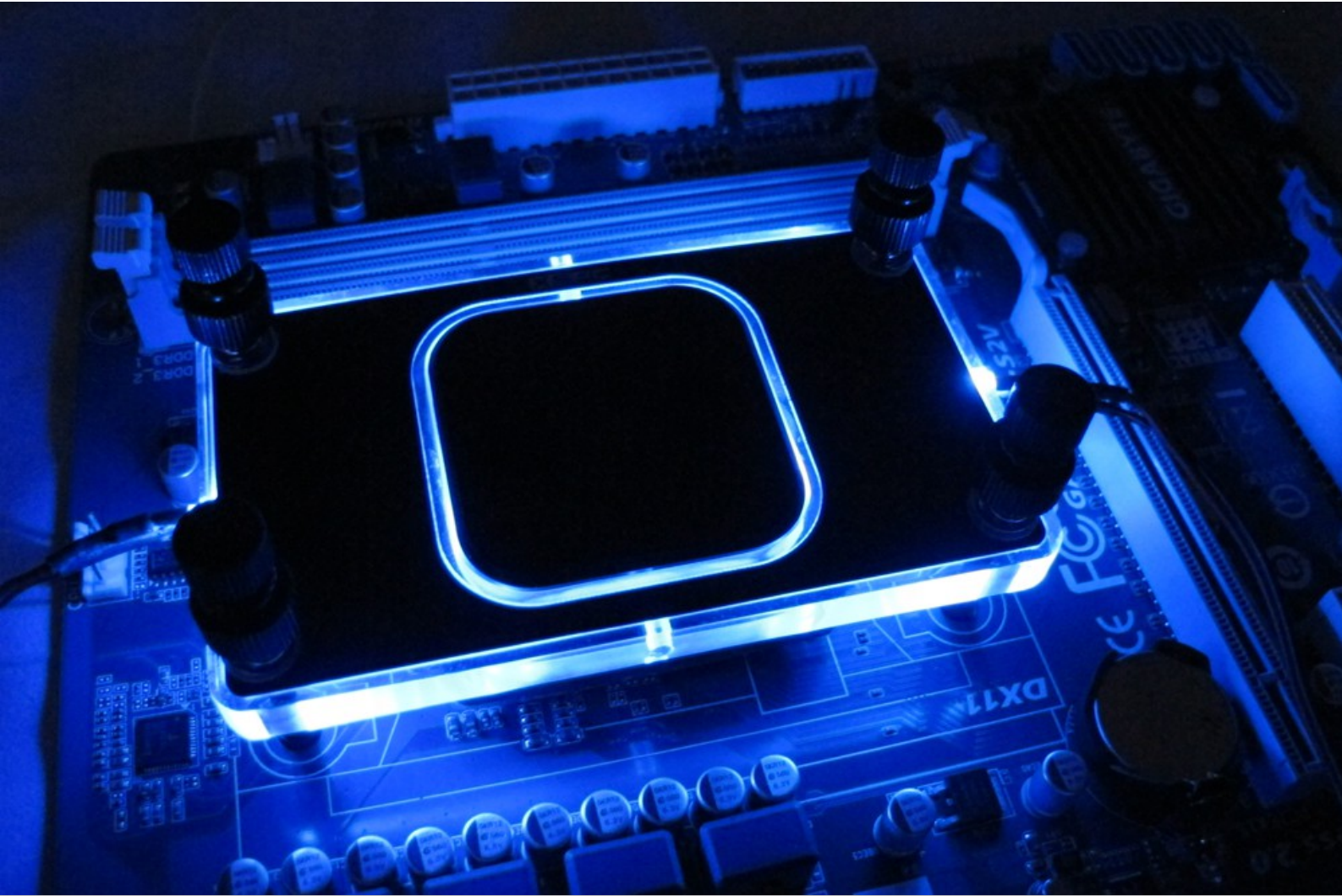

www.xs-pc.com/support

